

## **1. PRODUCT OVERVIEW**

Ancel HD series products are commercial vehicle diagnostic tools based on special Android tablet.

This product integrates commercial vehicle OBD standard diagnostic protocols, including SAE J1939, SAE J1708, SAE J1850 PWM, SAE J1850 VPW, ISO 14230-4, ISO 9141-2, ISO 15765-4 and ISO 27145-4. The commercial vehicles are classified according to the vehicle type information, and the operation interface is very clear, which makes it convenient for users to diagnose commercial vehicles.

There's a optional printer module available to have diagnosis data and report printed. At the same time, the product supports online upgrade of diagnostic program and diagnostic data.

## 2. PRODUCT STRUCTURE

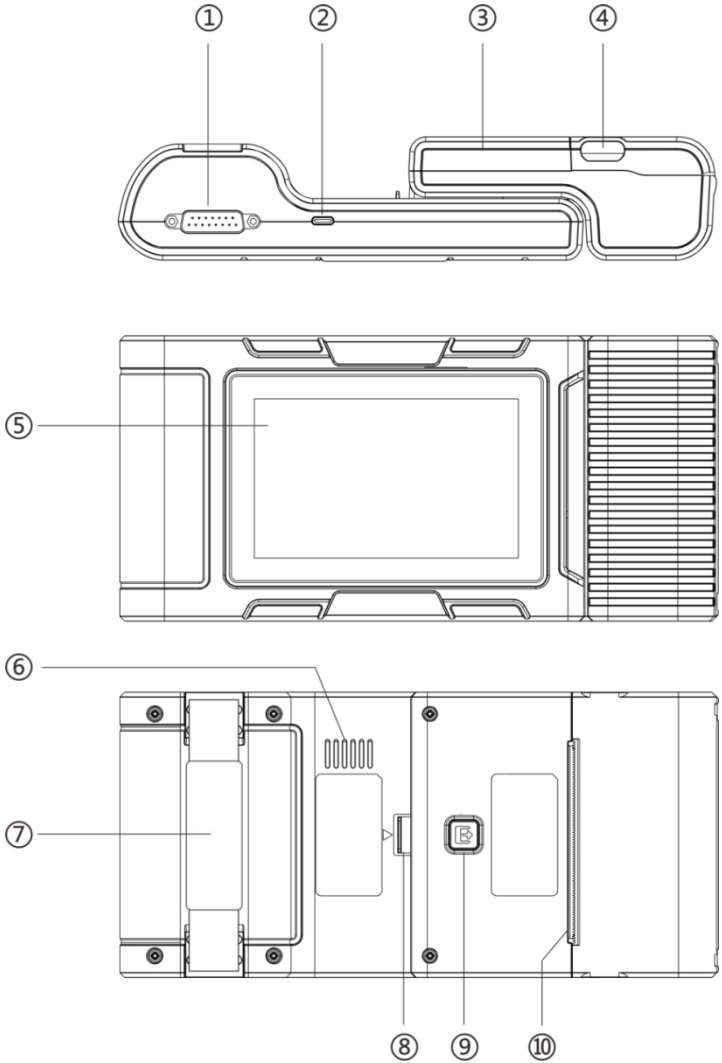

Serial No.	Name	Function Description
①	Main Testing Cable	Connection interface connects vehicle communication cable during vehicle diagnosis
②	USB Port	Used to connect to an external computer
③	Print	Used to print diagnostic reports and results
④	Paper bin cover	After opening, you can install and replace the printing paper
⑤	Touch screen	Display content and touch operation area
⑥	Speaker	Device sound output
⑦	Auxiliary bandage	Auxiliary for hand holding
⑧	Separation switch	Host and printer separation switch
⑨	Test key	Printer self test and paper feed button
⑩	Paper outlet	Printer paper outlet

### 3. HOST CONFIGURATION

<b>CPU</b>	Quad-Core ARM Cortex-A7
<b>RAM</b>	1GB
<b>Flash</b>	8GB
<b>Display</b>	5 inches LCD, resolution ratio 800*480
<b>TP touch screen</b>	Capacitive screen

<b>WIFI</b>	802.11b/g/n 2.4GHz
<b>Horn</b>	Support
<b>USB interface</b>	Type C interface
<b>Diagnose interface</b>	DB15 interface
<b>Operating voltage</b>	DC 10V~24V/3A
<b>Operating temperature</b>	-20°C~60°C
<b>Storage temperature</b>	-30°C~70°C

#### 4. PRINTER CONFIGURATION (OPTIONAL)

<b>Printer</b>	80mm thermal printer
<b>Print speed</b>	60mm/s
<b>Effective print width</b>	72mm
<b>Print resolution</b>	203dpi 1mm=8dots
<b>Print paper specifications</b>	80mm*30mm

#### 5. POWER ON/OFF

##### 1) Power on

The device can be powered on in the following ways:

Vehicle power on: plug one end of the main diagnostic test line into the DB-15 interface of the device, and the other end into the diagnostic interface of the vehicle, and the device will automatically start up . If it doesn't started up, it may be that there is no power supply for the vehicle diagnostic seat, and the device can be powered by the cigarette lighter or battery clamp.

Power on the power adapter: plug one end of the main diagnostic test line into the DB-15 interface of the device, connect the power adapter, and the device will start automatically.

**Note: the voltage of the power supply should be within the scope of application of the product equipment. If it is beyond the scope, the product may be damaged.**

## 2) Power off

Before power off, please stop all diagnostic items and return back to the main interface.

Pull out the diagnostic main test line from the diagnostic interface of the vehicle. If the device is not equipped with battery, the device will shut down automatically after disconnecting the main test line from the diagnostic interface of the vehicle.

## 6.VEHICLE DIAGNOSTIC PREPARATION

The diagnostic program establishes data connection through the vehicle electronic control system connected with the equipment, which can read the vehicle diagnostic information, view the data flow, and perform action test and other functions. For details of the functions, please refer to the model which you purchased.

To establish good communication between the diagnostic program and the vehicle, the following operations need to be performed:

- 1) Turn off the ignition;
- 2) Find the diagnostic interface of the vehicle: it is usually located on the driver side; If the diagnostic interface is not found,

please refer to the vehicle maintenance manual.

3) Insert one end of the diagnostic main test line into the device DB-15 connector and tighten the retaining screws. The other end is connected to the vehicle's diagnostic interface.

**Note: Before the equipment is connected to the vehicle, it is necessary to judge whether the diagnostic seat of the vehicle is a standard OBD-II interface or a non-standard OBD-II interface.**

- The vehicle compatible with OBD-II management system only needs to use the integrated main test line OBD connector to connect with the vehicle diagnosis seat and provide power;
- For vehicles that are not compatible with the OBD-II management system, the corresponding connector should be selected; Some vehicles need to be powered by other vehicle power sources.

The following is an operation description of these two connection modes.

### 1) Connection of standard OBD-II interface

The vehicle connected with standard OBD-II interface only needs to use the integrated main test line OBD connector, and no other connectors are needed, as shown in the figure:

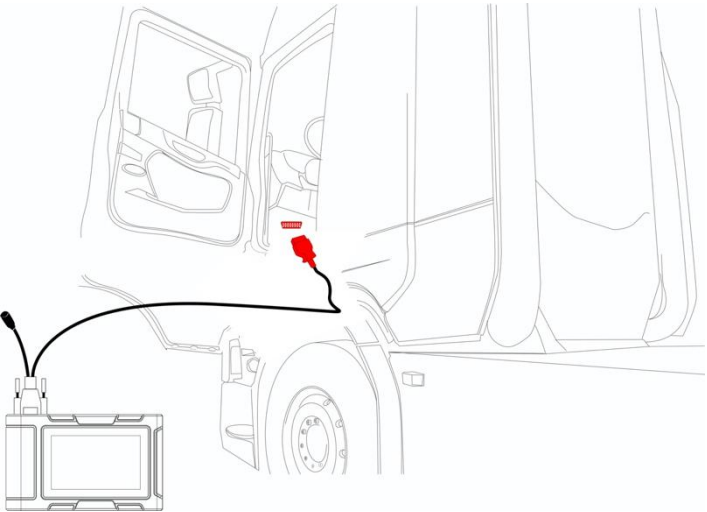

## 2) Connection of non OBD-II interface

Vehicles with non OBD-II interface need to connect the main test line with the corresponding special connector, as shown in the figure:

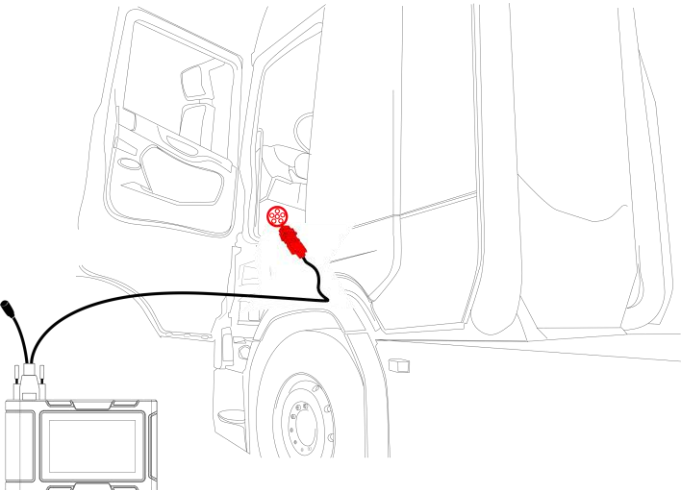





**Note:** at this time, the equipment is powered by the vehicle diagnosis seat, and the equipment starts automatically. If not, it may be that the vehicle diagnosis seat has no power supply, and the equipment can be powered by the cigarette lighter or battery clip.

## 7.INTRODUCTION OF EACH FUNCTION MENU











After the system is started, the main menu of function will be entered. The main menu of each version of model will be slightly different. Please refer to the display of the model you purchased.

- 1) Toolbar (see Table 1)
- 2) Function main menu (see Table 2)

**Table 1: Toolbar**









Icon	Function name	Function description
	Refresh	Refresh upgrade menu
	Home	Return to the main interface of the system
	Screenshot	Capture current screen picture
	Test report	Used to save test data during diagnosis (can be viewed in data management menu)



Icon	Function name	Function description
	Feedback	Used to report the problem to the company's service system (need to connect to the network) when the system cannot be accessed during the diagnosis process
	Print	Used to print test results or test reports. The printer is optional
	Edit	Used to edit files, lock, unlock or delete files
	Added	Used to add feedback information
	WIFI	WIFI connection network
	Brightness	Used to adjust the brightness of the device screen
	Volume	Used to adjust the volume of the device
	User info	Used to view device status and user information
	Data cleaning	Used to remove useless data from the device
	General	Used to set device language, unit and time, view device information and restore

	factory settings
--	------------------

**Table 2: Function main menu**

Icon	Function name	Function description
	Diesel OBD	Diagnostic procedure: Diesel OBD, see section 5 for details
	OBD-II	Diagnostic procedure: OBD-II, see section 5 for details
	Model diagnosis	The diagnosis menu of each model will be slightly different. Please refer to the model you purchased
	Service	DPF regeneration and maintenance lamp zero and other services. Please refer to the model you purchased
	Tools	(Pin Detect)For the measurement of pin voltage of diagnostic interface, see section 6 for details
	Data management	For browsing and managing saved data files, see section 7 for details
	Upgrade	For online upgrade of system software and vehicle software, see section 8 for details
	Settings	Set and view system information, see section 9 for details

## 8. DIAGNOSTIC FUNCTION

1) Take **【HD3200】** **【Diesel OBD】** as an example;

Click **【DIESEL OBD】** menu enter the diagnosis interface.



2) Select connector according to the specific situation, such as **【Diesel6&9PIN】** ;

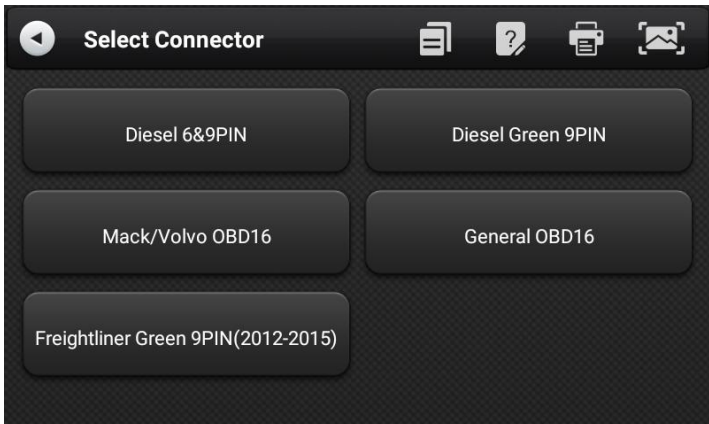

3) Select the required diagnostic method, such as **【Standard protocol(Fast Scan)】** ;



4) Click **【Start test】**

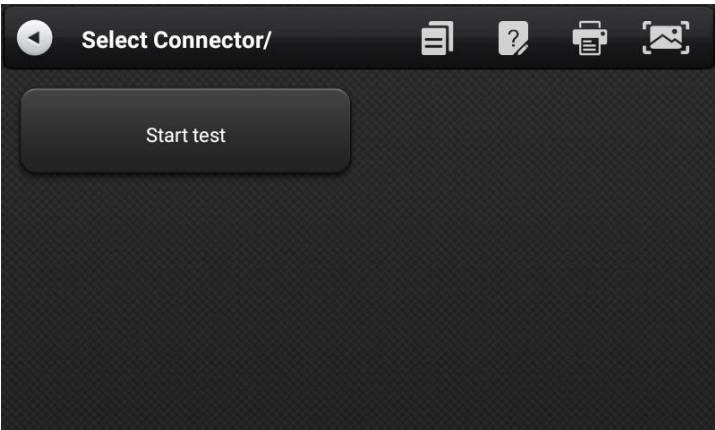

5) Select **【(J1939) Engine】** ;

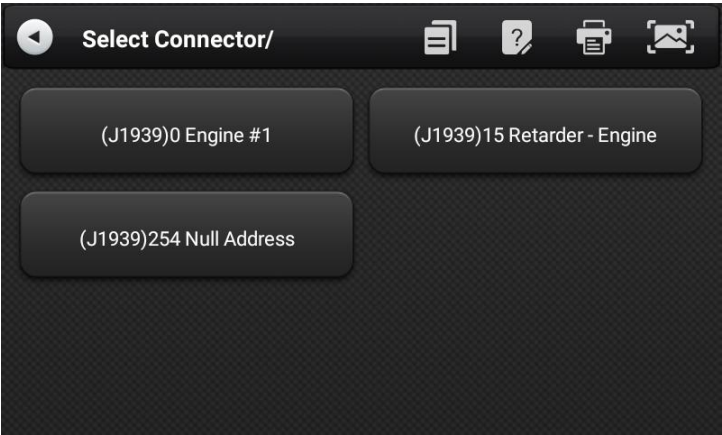

6) Enter **【Diagnosis home page】** ;

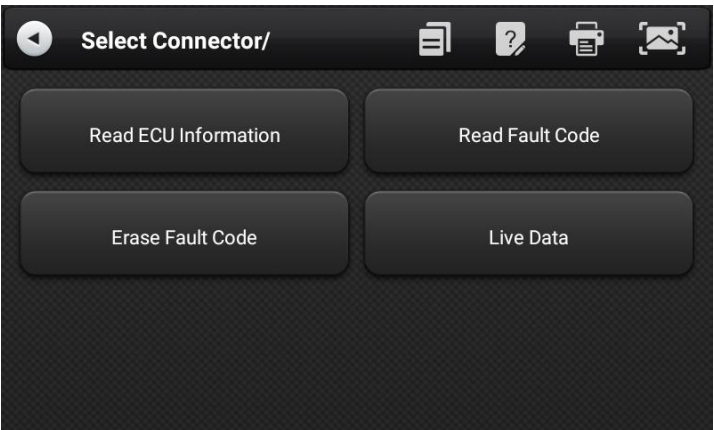

**The main diagnostic interface usually includes the following options:**

**ECU Information:** Read and display the control system module information detected from ECU

**Read Fault Code:** Read the fault code information retrieved from the vehicle system module

**Erase Fault Code:** Clear the fault code and freeze frame data

retrieved from the vehicle system module

**Live Data:** Read and display the real-time operation parameters of the current system module

## 9. PIN DETECT

This function mainly measures the voltage of 16 PIN of OBD diagnostic interface, and judges the pin position of K- line and CAN line.

After connecting the OBD interface of vehicle, click the main interface **【Tools】** to select pin detection. The program automatically measures the 16pin voltage of OBD diagnosis interface, and judges the pin position of K-line and can line, as shown in the figure below:



## 10. DATA MANAGEMENT

**【Data Management】** The function is used to save and view test reports, screenshots and problem feedback files. Most of the files are generated by executing the toolbar operation of the vehicle diagnosis interface.

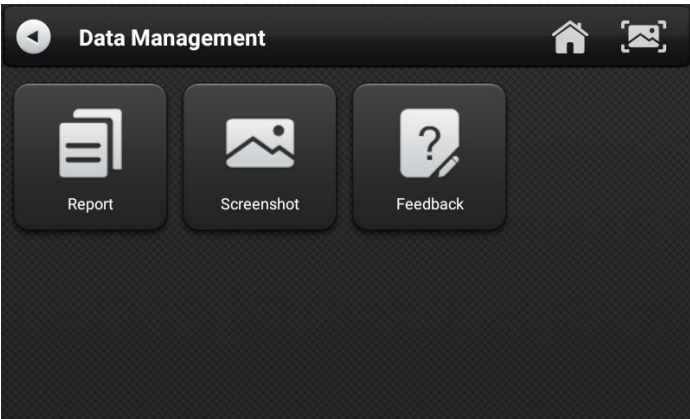

## 11. DIAGNOSTIC SOFTWARE UPGRADE

By connecting the device to the wireless network, the diagnostic software can be upgraded and the product function can be improved in time. Open **【Update】** in the function main menu, and the system will automatically search for the latest update program, as shown in the figure below. Click **【Update】** to upgrade the model and other applications to the latest version.

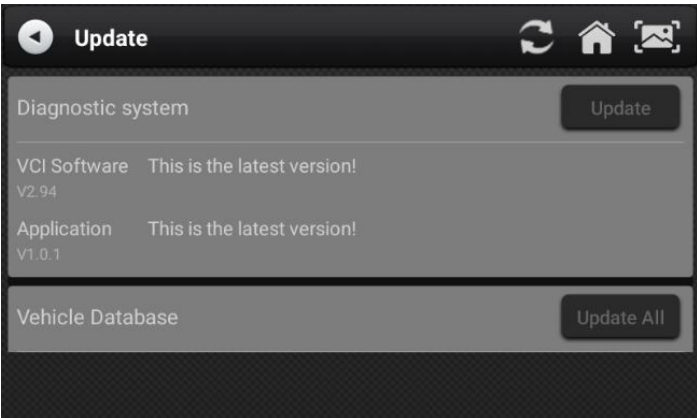

## 12. SETTINGS

Select **【Settings】** from the main menu to open the setting interface, where you can adjust the following system settings:



### 12.1 WIFI CONNECTION

The device supports wireless network connection for diagnosis software upgrade and problem feedback.

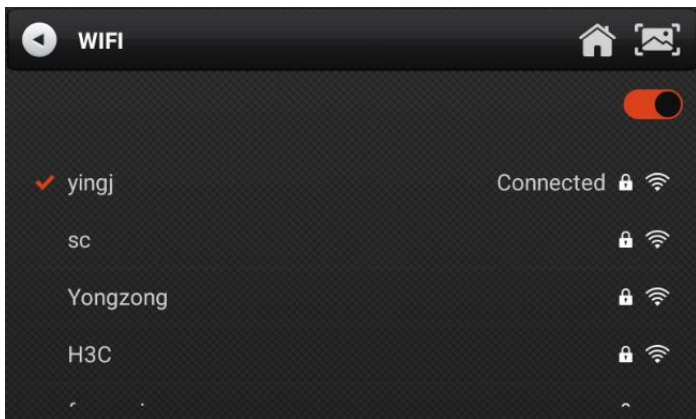

### 12.2 BRIGHTNESS

The device supports screen brightness setting, please adjust it according to your adaptive brightness.



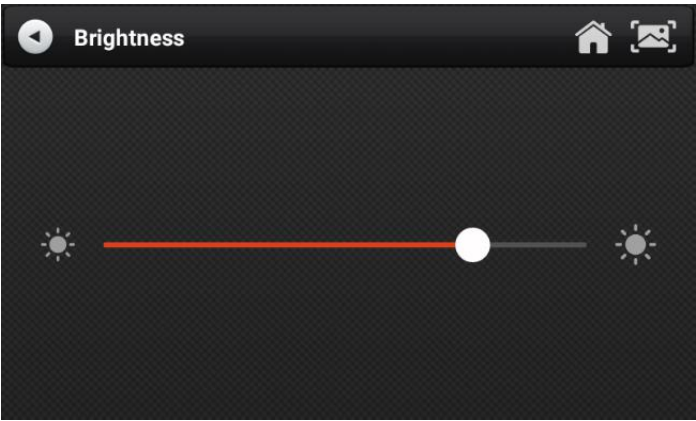

## 12.3 ACTIVATE

### 1) Activate

The products are not activated when they leave the factory.

Connect the network to enter the setting, and click **【Activate】** to activate the machine.

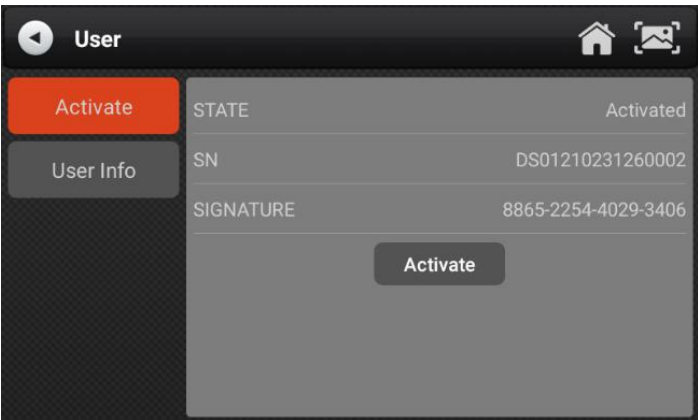

### 2) User Info

Set your personal information: name, telephone, email, address,

etc.

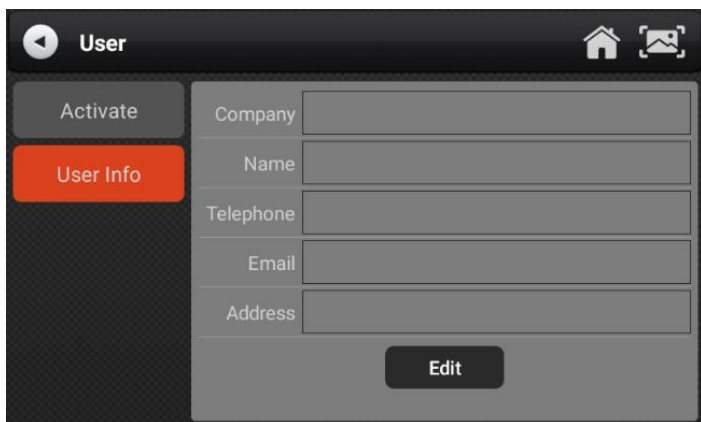

## 12.4 DATA CLEANING

Cleaning up useless data with one click, freeing up more space and cleaning up regularly will help the system run more stably.

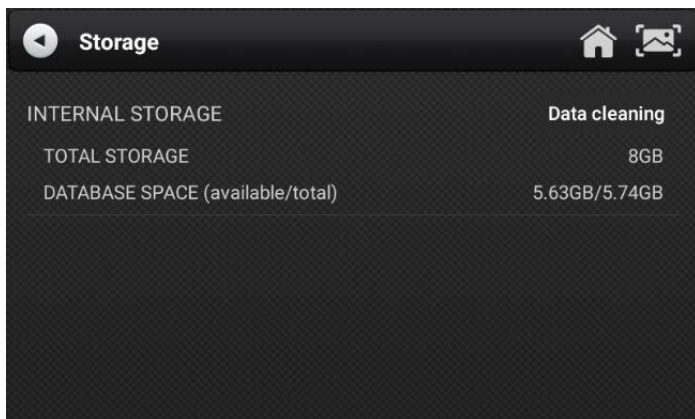

## 12.5 General

### 1) Language

Please select settings based on the language you support for

the model you purchased.

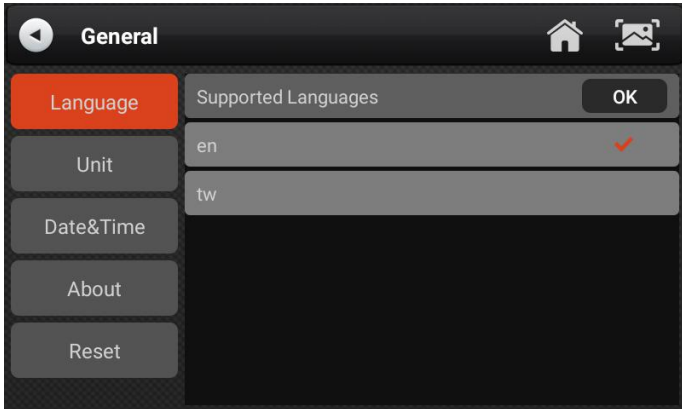

## 2) Unit

This option can set the data flow unit in the diagnostic equipment software. Please select metric system or English system as required.

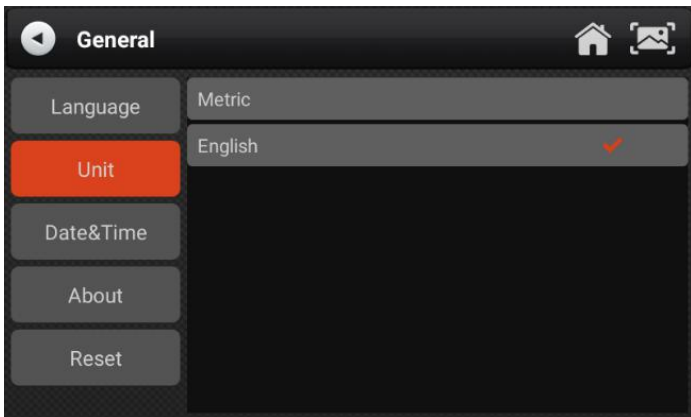

## 3) Date&Time

This option can set the date / time of the device. The default is automatic network synchronization update, or it can be set manually.

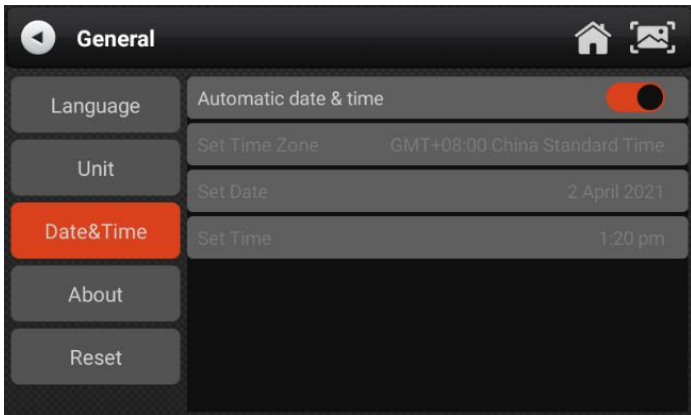

#### 4) Reset

This option can restore the original settings of the device, which will delete all the data stored in the device, including the activation information and model data. You need to re-connect the network to activate and download the model data package.

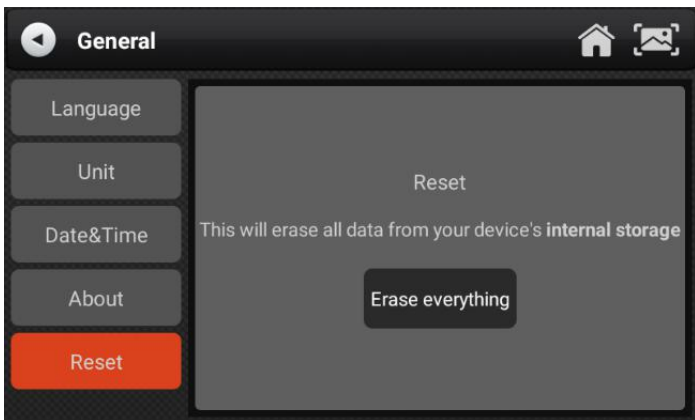

## 13. PRINTER INTRODUCTION

### 1) Printer combination and split

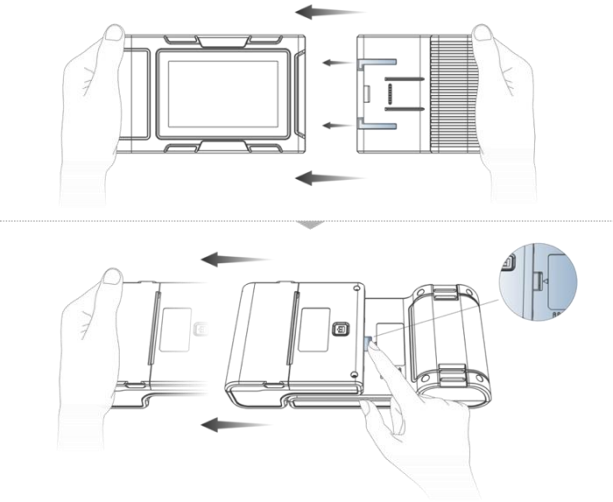

1. Hold the printer in your hand, aim at the lead-in slot on the back of the main unit, push it in slightly, and you will hear a “click” voice, which means the main unit and the printer has already connected together.
  2. After pressing the separation switch, hold the printer in your hand and gently pull it out. The printer will be separated from the host.
- 2) Printer loading and changing paper

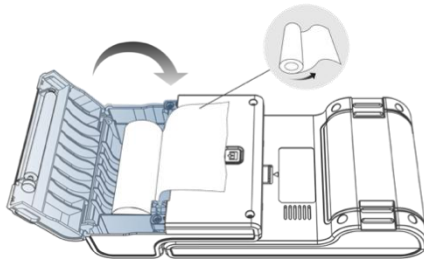
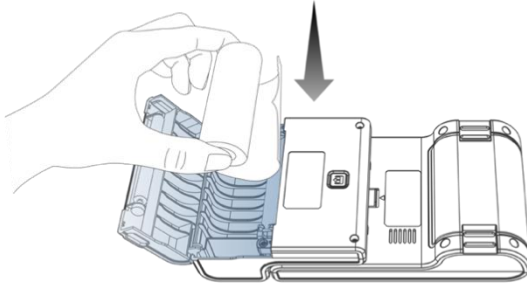
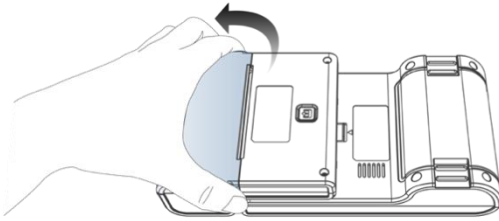

1. Hold the position of the printer paper bin cover with your fingers and open the cover up;
2. Put the printing paper into the paper bin according to the diagram. Pay attention to the direction of the paper. If the installation is reversed, the printing will be blank;
3. Just close the paper bin cover.

### 3) Printer self test function

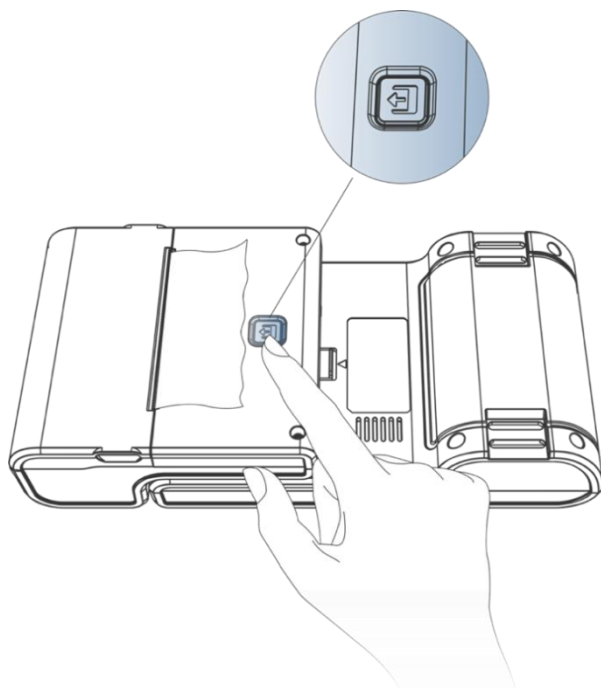

1. When the machine is turned on, press the printer test key briefly, and the printer will automatically print out a piece of blank paper.
2. In the case of power on, long press the printer test key for three seconds, the printer will automatically print a section of self-test content, indicating that the printer function is normal.

## Certification

**This product has been inspected and certified to meet the company's quality standards.**

Product name	
Product serial number	
Date of production	
Inspector	

## Warranty card

Product name	
Product serial number	
Purchase date	

**Company name:** \_\_\_\_\_

**User address:** \_\_\_\_\_

**Contact person:** \_\_\_\_\_

**Contact number:** \_\_\_\_\_